

# 1

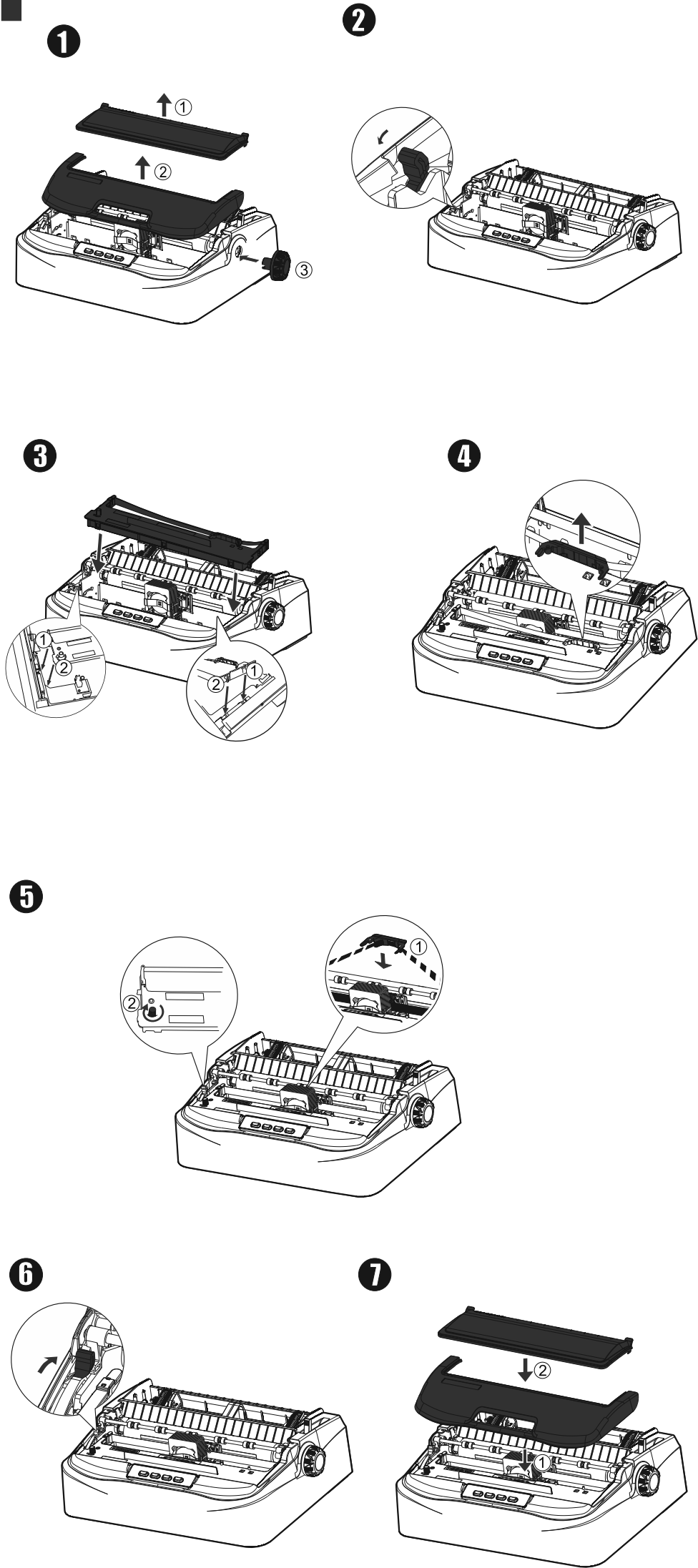

# 2

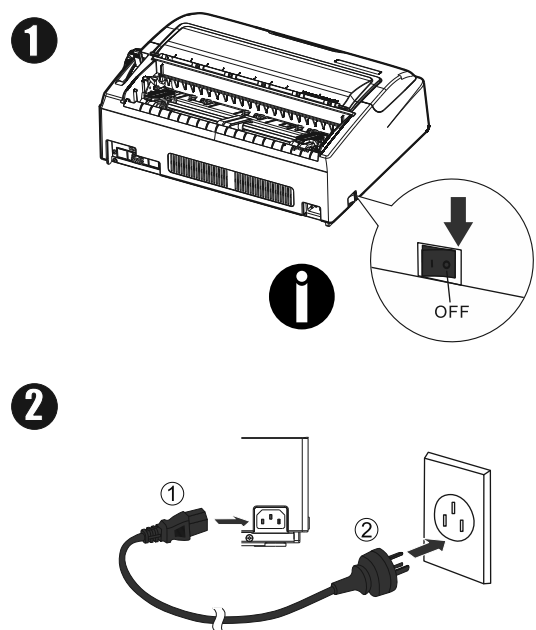

# 3

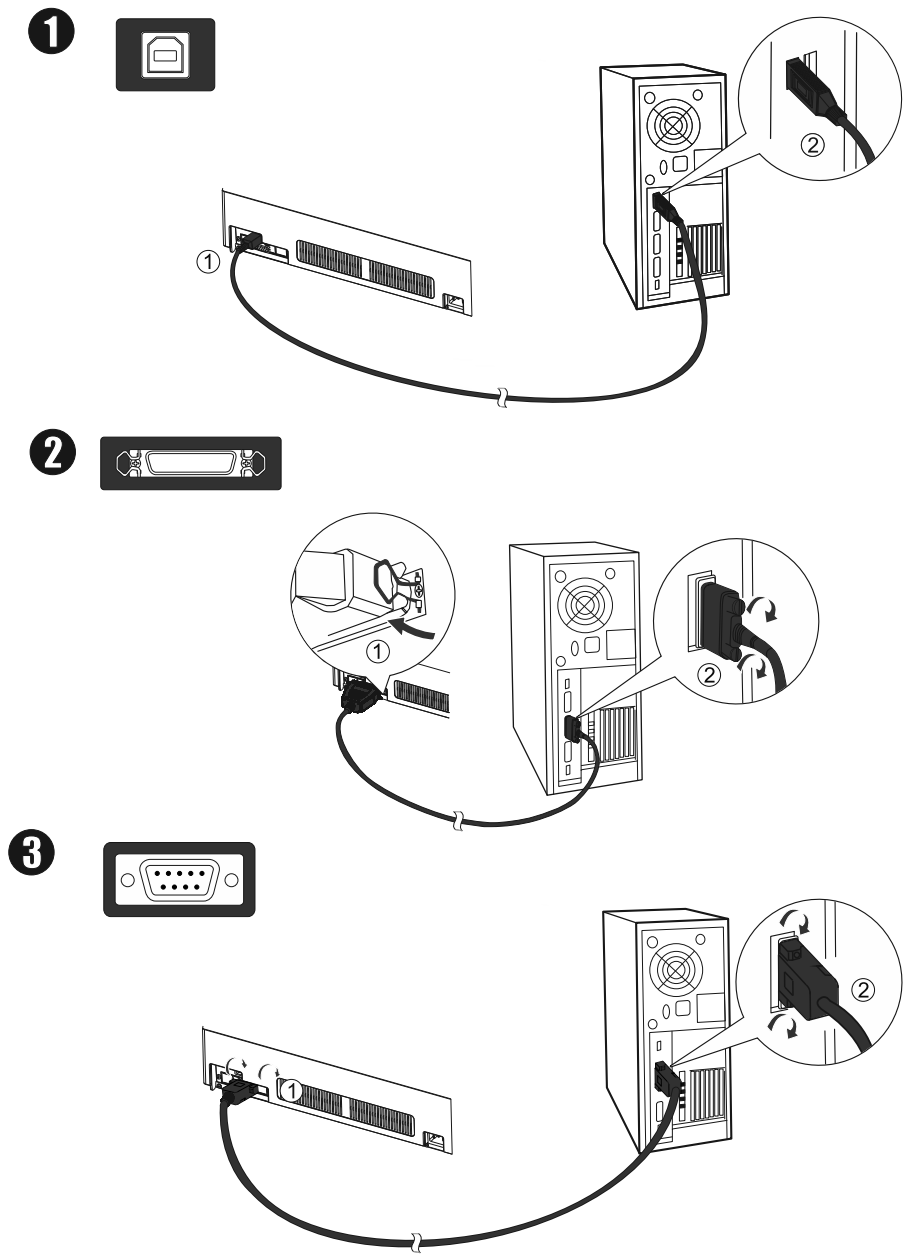

# 4

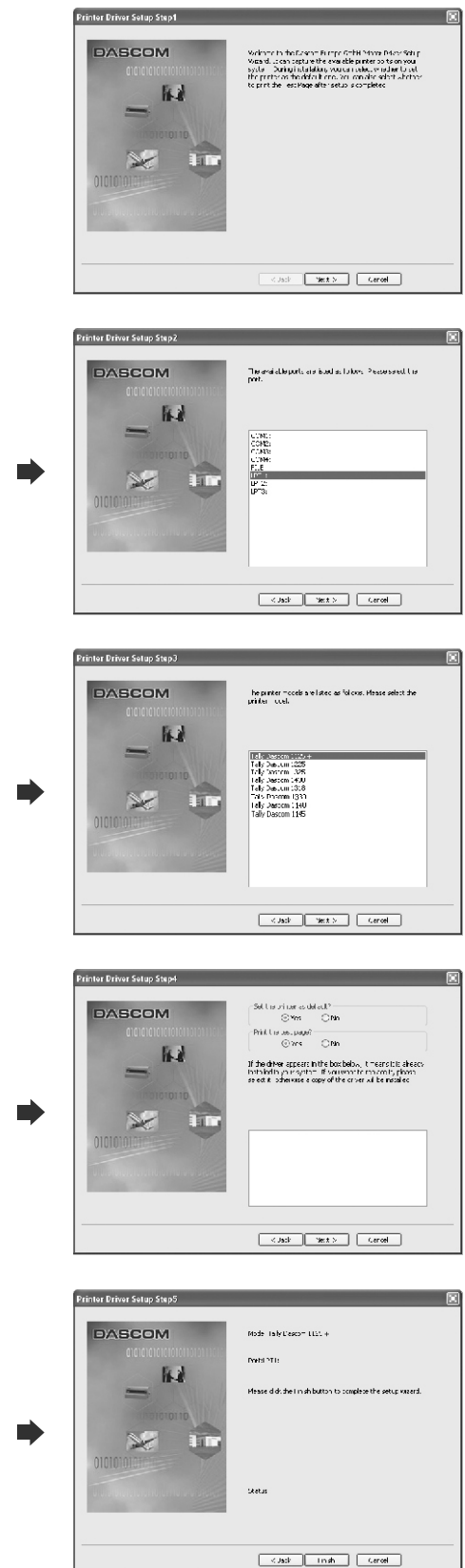

# 5

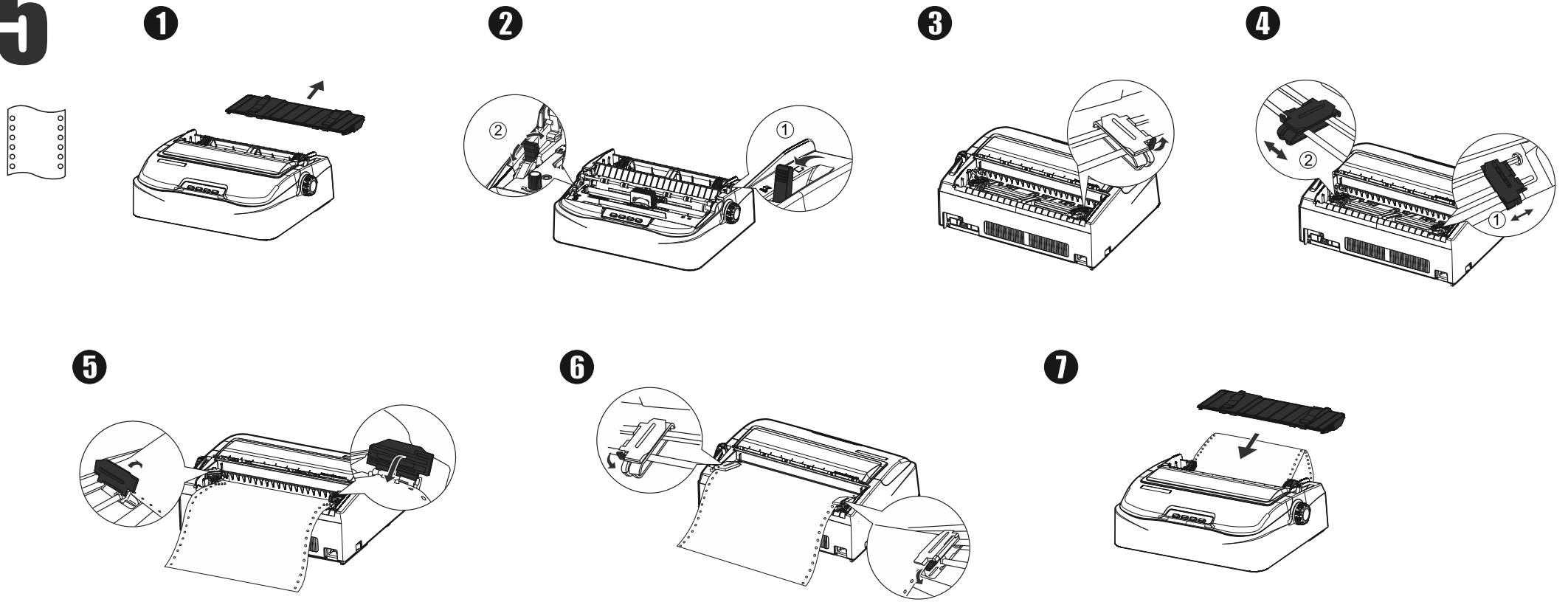

# 6

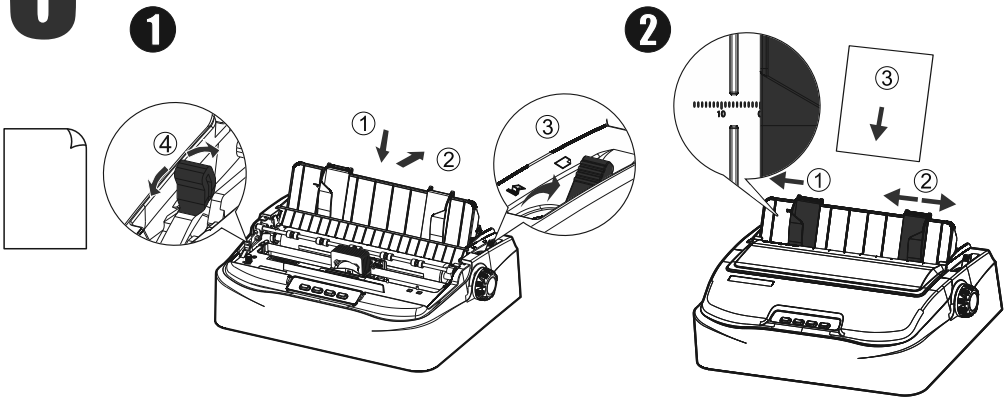

## Questions



1 1 4 0 / 1 1 2 5 + / 1 1 4 5

## Installation Guide

**Tally**  
**DASCOM**

EN

Installation guide  
Please read the following instructions carefully before operating the printer. For detailed information and safety recommendations see the User Guide available at <https://www.dascom.com/downloads.html>

GE

Installationshandbuch  
Lesen Sie bitte diese Hinweise durch bevor sie den Drucker in Betrieb nehmen. Ausführliche Informationen und Sicherheitsempfehlungen finden Sie im User Guide auf <https://www.dascom.com/downloads.html>

FR

Guide d'installation  
Lire attentivement les instructions suivantes avant de mettre l'imprimante en service. Pour plus d'informations et de recommandations concernant la sécurité, merci de vous reportez-vous au manuel de l'utilisateur sur le <https://www.dascom.com/downloads.html>

IT

Guida di installazione  
Prima di mettere in funzione la stampante, leggere attentamente le seguenti indicazioni. Per informazioni dettagliate e suggerimenti sulla sicurezza consultare il manuale User Guide sul <https://www.dascom.com/downloads.html>

SP

Guía de instalación  
Lea las siguientes instrucciones detalladamente antes de poner la impresora en funcionamiento. Para obtener información detallada y recomendaciones de seguridad consulte la Guía de Usuario disponible en <https://www.dascom.com/downloads.html>

RU

Руководство по установке  
Прочтите, пожалуйста, инструкцию по технике безопасности перед включением в работу принтера. Подробная информация и инструкция по технике безопасности Вы найдете в руководстве пользователя по ссылке: <https://www.dascom.com/downloads.html>

PT

Guia de instalação  
Leia atentamente as instruções a seguir antes de operar a impressora. Para informações detalhadas e recomendações de segurança, consulte o Guia do Usuário disponível em <https://www.dascom.com/downloads.html>

TR

Kurulum kılavuzu  
Yazıcımızı çalıştırmadan önce, aşağıda belirtilen talimatların hepsini okuyunuz. Detaylı bilgi ve güvenli çalışma tavsiyeleri için, <https://www.dascom.com/downloads.html> linkinde bulunan kullanım kılavuzuna başvurunuz.

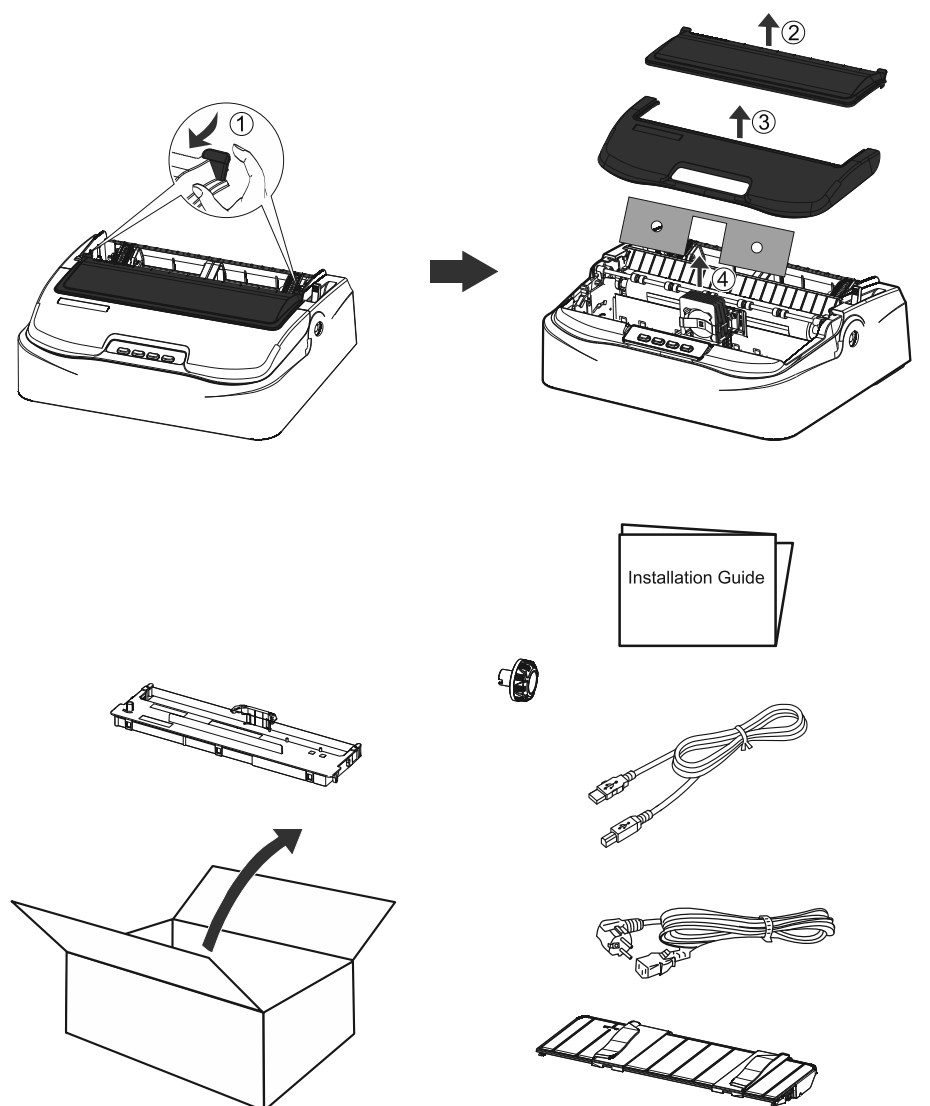

### DASCOM REPRESENTATIVES:

DASCOM Europe GmbH, Heuweg 3, D-89079 Ulm, Germany  
DASCOM GB Ltd, Hart House, Priestley Road, Basingstoke, Hampshire, RG24 9PU, England  
DASCOM AP Pte Ltd 2 Jurong East Street 21#05-42, IMM Building, Singapore 609601  
DASCOM Americas LLC, 34 Lakeview Court, Verona, VA 24482, USA

Copyright © 2024 Dascom [www.dascom.com](http://www.dascom.com)

21.511.824.0015R